

# BIO LUMBER

**TENDENZA NATURA**  
*nature feeling*



**LEA**  
CERAMICHE



**TENDENZA  
NATURA**  
Nature  
Feeling



**BIO LUMBER  
LODGE GROVE**

**Pavimento / Floor**  
nat. rett. 20x120cm / 8"x48"  
deco cluster mix 20x20cm / 8"x8"



**BIO LUMBER  
LODGE BROWN**

**Pavimento / Floor**  
nat. rett. 20x120cm / 8"x48"

**BIO LUMBER  
LODGE GROVE**

**Pavimento / Floor**  
nat. rett. 20x120cm / 8"x48"  
deco cluster mix 20x20cm / 8"x8"

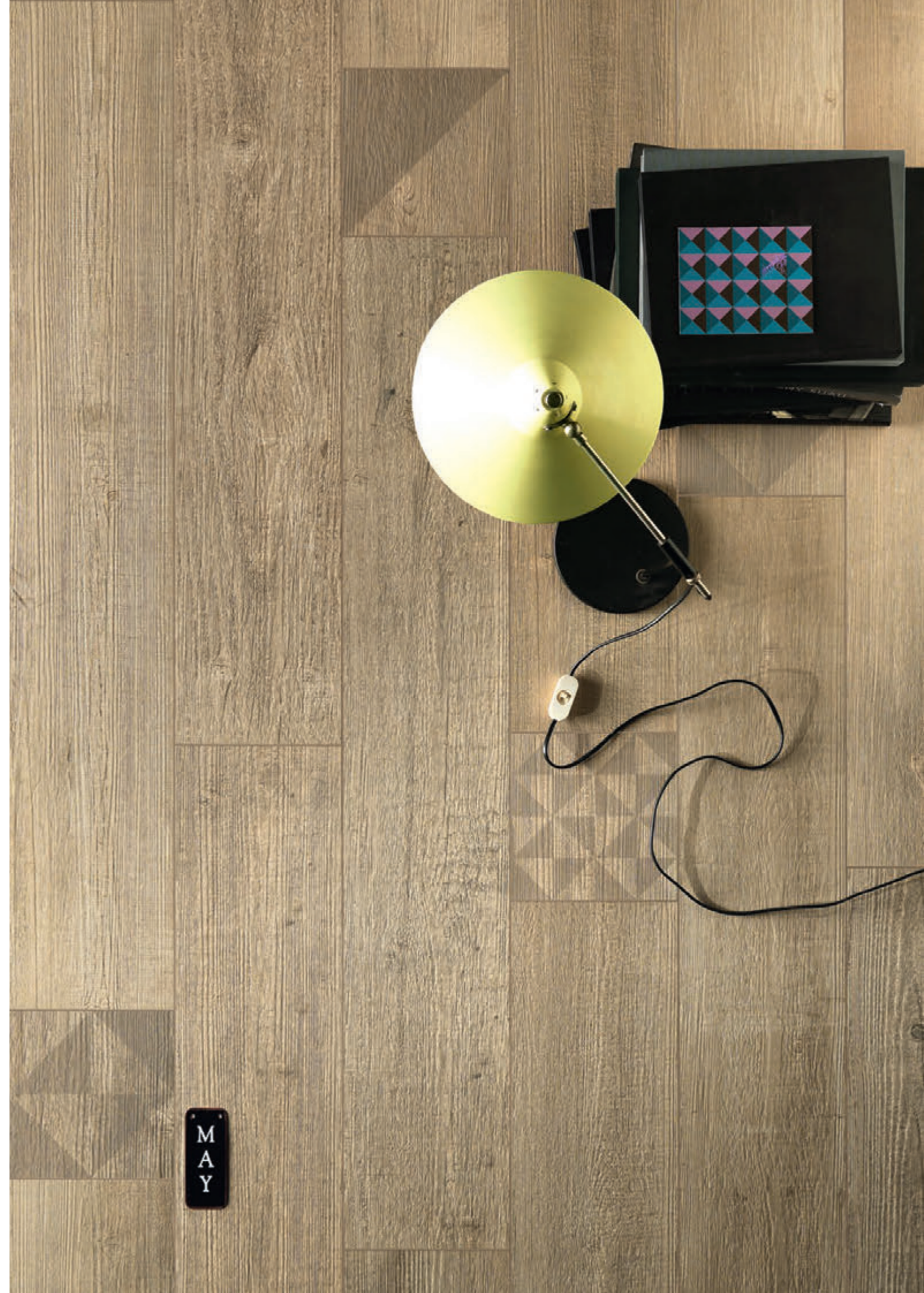

**BIO LUMBER  
LODGE BROWN**

**Pavimento / Floor**  
nat. rett. 30x120cm / 12"x48"  
nat. rett. 20x120cm / 8"x48"



**LIVING**



## RESTAURANT

---

**BIO LUMBER  
LODGE GREY**

**Pavimento / Floor**  
nat. rett. 20x120cm / 8"x48"  
decoro beehive 20x120cm / 8"x48"



**BIO LUMBER  
LODGE GROVE**

Pavimento / Floor  
nat. rett. 20x120cm / 8"x48"  
deco cluster mix 20x20cm / 8"x8"





**BIO LUMBER  
LODGE GREIGE**

**Pavimento / Floor**  
nat. rett. 20x120cm / 8"x48"

## PUBLIC AREAS

---

### BIO LUMBER LODGE BROWN

**Pavimento / Floor**  
nat. rett. 30x120cm / 12"x48"  
nat. rett. 20x120cm / 8"x48"



**BIO LUMBER  
LODGE GROVE**

Pavimento / Floor  
nat. rett. 20x120cm / 8"x48"  
deco beehive 20x120cm / 8"x48"

**BIO LUMBER  
LODGE GREY**

**Pavimento / Floor**  
nat. rett. 20x120cm / 8"x48"



**BIO LUMBER  
LODGE GREIGE**

**Pavimento / Floor**  
nat. rett. 20x120cm / 8"x48"  
decoro cluster mix 20x20cm / 8"x8"





**BIO LUMBER  
LODGE GREY**

**Pavimento / Floor**  
nat. rett. 20x120cm / 8"x48"

**LODGE GROVE**



30x120cm / 12"x48"

LG6BL30

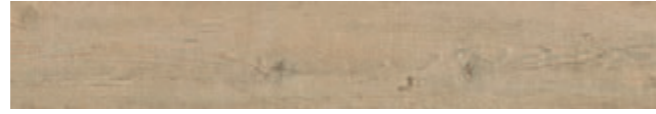

20x120cm / 8"x48"

LG7BL30



CLUSTER MIX  
20x20cm / 8"x8"  
lodge grove

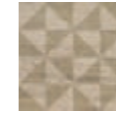

LGHBL30



BEEHIVE  
20x120cm / 8"x48"  
lodge grove

LG7BLB3

**LODGE GREIGE**



30x120cm / 12"x48"

LG6BL10



20x120cm / 8"x48"

LG7BL10



CLUSTER MIX  
20x20cm / 8"x8"  
lodge greige



LGHBL10

**LODGE BROWN**



30x120cm / 12"x48"

LG6BL00



20x120cm / 8"x48"

LG7BL00



CLUSTER MIX  
20x20cm / 8"x8"  
lodge brown

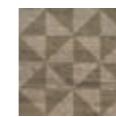

LGHBL00

**LODGE GREY**



30x120cm / 12"x48"

LG6BL20



20x120cm / 8"x48"

LG7BL20



CLUSTER MIX  
20x20cm / 8"x8"  
lodge grey



LGHBL20



BEEHIVE  
20x120cm / 8"x48"  
lodge grey

LG7BLB2

## FORMATI E COLORI 20mm

SIZES AND COLORS 20mm\_FORMATS ET COULEURS 20mm\_FORMATE UND FARBEN 20mm

### LODGE GROVE L2



30x120cm / 12"x48"  
nat. rett.

LG6K235

### LODGE GREIGE L2



30x120cm / 12"x48"  
nat. rett.

LG6K215

### LODGE BROWN L2



30x120cm / 12"x48"  
nat. rett.

LG6K205

### LODGE GREY L2



30x120cm / 12"x48"  
nat. rett.

LG6K225

## PEZZI SPECIALI

TRIMS\_PIECES SPÉCIALES\_FORMSTÜCKE

### NATURALE

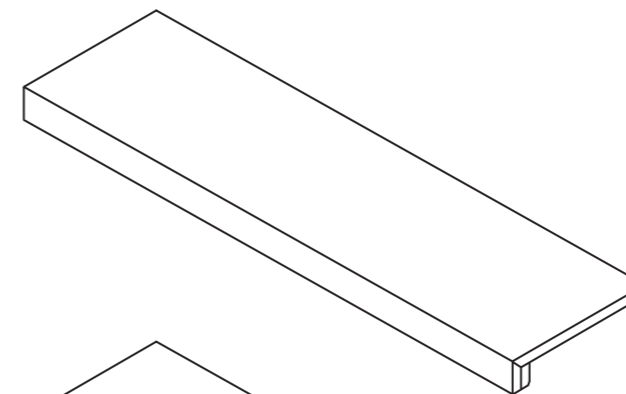

ANGOLO SX GRADINO PLUS nat. rett.\*  
35x120cm / 13<sup>3/4</sup>"x48"  
lodge greige LG9BLS1  
lodge brown LG9BLS0  
lodge grey LG9BLS2  
lodge grove LG9BLS3

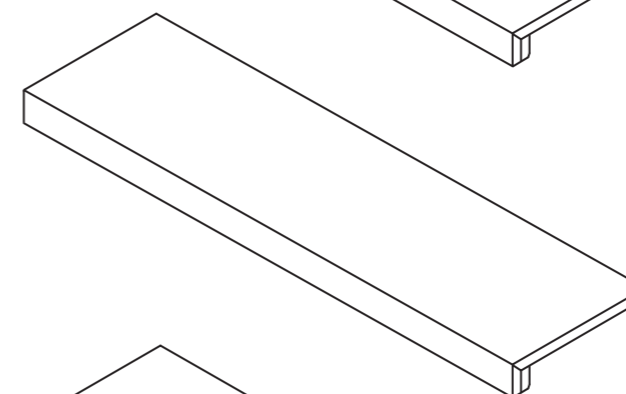

GRADINO PLUS nat. rett.\*  
35x120cm / 13<sup>3/4</sup>"x48"  
lodge greige LG9BL10  
lodge brown LG9BL00  
lodge grey LG9BL20  
lodge grove LG9BL30

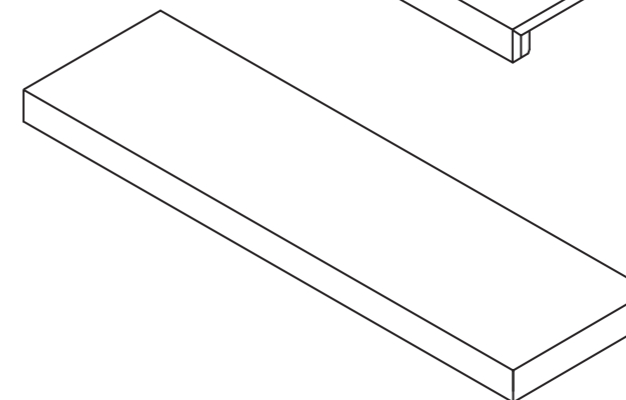

ANGOLO DX GRADINO PLUS nat. rett.\*  
35x120cm / 13<sup>3/4</sup>"x48"  
lodge greige LG9BLD1  
lodge brown LG9BLD0  
lodge grey LG9BLD2  
lodge grove LG9BLD3

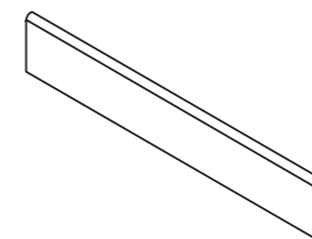

BATTISCOPA nat. rett.  
10x60cm / 4"x24"  
lodge greige LGBBL10  
lodge brown LGBBL00  
lodge grey LGBBL20  
lodge grove LGBBL30



RACCORDO JOLLY nat.  
1,3x30cm / 1/2"x12"  
lodge greige LG9BL61  
lodge brown LG9BL60  
lodge grey LG9BL62  
lodge grove LG9BL63



BEAK JOLLY nat.  
1,3x2cm / 1/2"x3/4"  
lodge greige LG9BL51  
lodge brown LG9BL50  
lodge grey LG9BL52  
lodge grove LG9BL53





## BIO LUMBER

### gres tutta massa UGL









full-body porcelain  
grès cérame en pleine masse  
vollgemischtes durchgefärbtes feinsteinzeug









### spessore 10mm / 20mm

thickness  
épaisseur  
stärke

CARATTERISTICHE TECNICHE* TECHNICAL CHARACTERISTICS CARACTÉRISTIQUES TECHNIQUES TECHNISCHE EIGENSCHAFTEN	metodo di prova test method methode d'essai prüfmethode	valori medi average values valeurs moyens durchschnittliche werte
 <b>assorbimento d'acqua (E)</b> water absorption (E) absorption d'eau (E) wasserabsorption (E)	ISO 10545-3	≤ 0,04%
 <b>resistenza al gelo</b> frost resistance résistance au gel frostbeständigkeit	ISO 10545-12	resistente résistant beständig
 <b>resistenza alla flessione</b> bending strength résistance à la flexion beugefestigkeit	ISO 10545-4	≥ 50 N/mm <sup>2</sup>
 <b>sforzo di rottura (S)</b> breaking strength (S) chargement de rupture (S) bruchlast (S)	ISO 10545-4	spess. 10mm: ≥ 2500 N spess. 11mm: ≥ 3000 N spess. 20mm: ≥ 13600 N
 <b>resistenza all'abrasione profonda</b> résistance to deep abrasion résistance à l'abrasion profonde widerstand gegen tiefenabrieb	ISO 10545-6	≤ 145 mm <sup>3</sup>
 <b>dilatazione termica lineare</b> thermal expansion dilatation thermique linéaire thermische dilatation	ISO 10545-8	α ≤ 7x10 <sup>-6</sup> °C <sup>-1</sup>
 <b>resistenza agli sbalzi termici</b> thermal shock resistance résistance aux chocs thermiques temperatur wechselbeständigkeit	ISO 10545-9	resistente résistant beständig
 <b>resistenza attacco chimico</b> chemical resistance résistance chimique chemischee beständigkeit	ISO 10545-13	UHA, ULA resistente résistant beständig
 <b>resistenza alle macchie</b> stain resistance résistance aux taches fleckenbeständigkeit	ISO 10545-14	5 resistente résistant beständig
 <b>resistenza allo scivolamento</b> slip resistance résistance au glissement rutschfestigkeit	DIN 51130	R10 R11 (20mm)
 <b>resistenza allo scivolamento</b> slip resistance résistance au glissement rutschfestigkeit	DIN 51097	B (A+B) C (A+B+C) (20mm)
 <b>coefficiente di attrito dinamico</b> dynamic friction coefficient coefficient de friction dynamique dynamischer reibungskoeffizient	B.C.R. tortus	μ > 0,40
 <b>dynamic coefficient of friction (DCOF)</b>	ANSI A 137.1:2012	DCOF ≥ 0.42
 <b>wet pendulum test AUS</b>	AS 4586:2013	class P3(X) class P4(W) (20mm)
 <b>pendulum test UK</b>	BS 7976:2002	slider 96 wet: 36+ slider 55 wet: 36+ (20mm)
 <b>stonalizzazione</b> shading denuançage spieifarbig		V4

\*ISO 13006-G Bla UGL – EN 14411-G Bla UGL – ANSI A 137.1 (Un glazed Porcelain Tiles - Class P1)

IMPIEGHI USES EMPLOI ANWENDUNGSBEREICHE		
 <b>alberghi</b> hotels hotels hotels		 <b>locali pubblici</b> public spaces lieux publics öffentliche bereiche
 <b>abitazioni</b> housing maisons wohnbereiche		 <b>aeroporti</b> airports aéroports flughafen
 <b>bar - ristoranti</b> bar - restaurants bar - restaurants cafés - restaurants, gasthäuser		 <b>centri commerciali</b> malls centre commerciaux einkaufszentren
 <b>negozi</b> shops magasins geschäfte		 <b>stazioni</b> train stations gares bahnhöfe

IMPIEGHI SYSTEM L2 USES EMPLOI ANWENDUNGSBEREICHE		
 <b>violetti</b> walkways allées Kleine Wege		 <b>parcheggi</b> parking areas parkings Parkplätze
 <b>parchi pubblici - giardini</b> public parks - gardens parcs publics et jardins Öffentliche Parks und Gärten		 <b>terrazze</b> terraces terrasses Terrassen
 <b>camminamenti piscine</b> pool decks voies piétonnes et piscines Wege und Schwimmbäder		 <b>zone industriali</b> industrial areas zones industrielles Industriebereiche
 <b>stabilimenti balneari</b> beach resorts établissements balnéaires Badeanstalten		 <b>aree urbane</b> urban areas zones urbaines Stadtgebiete

### IMBALLAGGI PACKING EMBALLAGE VERPACKUNGEN

articolo	scatola			europallet				
	pz.	m <sup>2</sup>	kg	scat.	m <sup>2</sup>	kg		
fondo	30x120	12"x48"	4	1,44	34,0	18	25,9	612,0
fondo	20x120	8"x48"	5	1,20	27,8	24	28,8	666,0
decoro beehive	20x120	8"x48"	2	0,48	11,5	20	9,6	230,0
decoro cluster mix	20x20	8"x8"	6	0,24	6,0	60	14,4	360,0
battiscopa	10x60	4"x24"	12	7,2 m.l.	18,0	60	432,0 m.l.	1080,0
gradino plus	35x120	13 <sup>3</sup> / <sub>4</sub> "x48"	2	0,84	23,2	16	13,4	371,2
angolo gradino plus	35x120	13 <sup>3</sup> / <sub>4</sub> "x48"	1	0,42	12,0	16	6,7	192,0
raccordo jolly	1,3x30	1/2"x12"	16	-	1,3	-	-	-
beak jolly	1,3x2	1/2"x3/4"	4	-	0,1	-	-	-



ISO 14001



ISO 9001



emas

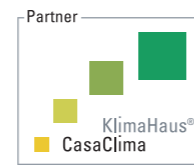

casaclima



leed

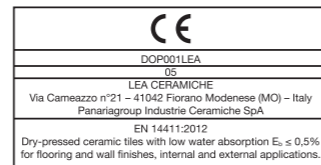

marchio CE



leed

\* LEED  
Lea Ceramiche, tramite la holding Panariagroup Industrie Ceramiche S.p.A., è socio ordinario del Green Building Council e del GBC Italia. Through Panariagroup Industrie Ceramiche S.p.A., Lea Ceramiche is an ordinary member of the Green Building Council and the GBC Italia. Par le biais de Panariagroup Industrie Ceramiche S.p.A., Lea Ceramiche est membre ordinaire du Green Building Council et du GBC Italia. Lea Ceramiche, durch die Holding Panariagroup Industrie Ceramiche S.p.A., ist ordentliches Mitglied von dem Green Building Council und dem GBC Italien. Lea Ceramiche, a través del holding Panariagroup Industrie Ceramiche S.p.A., es miembro afiliado del Consejo Construcción Verde y del Consejo Construcción Verde de Italia.

\*\* LEED  
Il contenuto di materiale riciclato "pre-consumo" della serie Bio Lumber è del 40%, come certificato da ente esterno qualificato (certificato disponibile sul sito [www.ceramichelea.com](http://www.ceramichelea.com)). Bio Lumber is produced with 40% of pre-consumer materials, as certified by a qualified external company (certificate available on the website [www.ceramichelea.com](http://www.ceramichelea.com)).

\*\*\* CASACLIMA  
Lea Ceramiche, tramite la holding Panariagroup Industrie Ceramiche S.p.A., ha ottenuto la certificazione Partner Casaclima. Through Panariagroup Industrie Ceramiche S.p.A., Lea Ceramiche has obtained the Partner Casaclima certification. Par le biais de Panariagroup Industrie Ceramiche S.p.A., Lea Ceramiche a obtenu la certification Partner Casaclima. Lea Ceramiche, durch die Holding Panariagroup Industrie Ceramiche S.p.A., hat die Bescheinigung als Partner Casaclima bekommen. Lea Ceramiche, a través del holding Panariagroup Industrie Ceramiche S.p.A., ha obtenido la certificación Partner Casaclima.



**LEA CERAMICHE HA SCELTO MICROBAN®,  
IL LEADER MONDIALE NELLA PROTEZIONE ANTIBATTERICA**  
*LEA CERAMICHE CHOOSES MICROBAN®,  
THE GLOBAL LEADER IN ANTIMICROBIAL TECHNOLOGY*

- PROTEZIONE 24 ORE SU 24  
*24/7 COVERAGE*
- EFFICACE CONTRO MACCHIE E ODORI CHE CAUSANO BATTERI  
*EFFECTIVE AGAINST STAIN AND ODOR CAUSING BACTERIA*
- MOLTEPLICI APPLICAZIONI ED UTILIZZI  
*MULTIPLE APPLICATIONS*
- TRATTAMENTO PERMANENTE  
*PERMANENT PROTECTION*
- INTEGRATA NELLA PIASTRELLA  
*INTEGRATED IN THE TILE*
- EFFICACE SU OGNI SUPERFICIE  
*EFFICIENT ON ANY SURFACE*

# BIO LUMBER

TENDENZA NATURA  
*nature feeling*



# LEA

CERAMICHE

LEA CERAMICHE  
Via Cameazzo, 21  
41042 Fiorano Modenese  
Modena Italy

Tel +39 0536 837811  
Fax +39 0536 830326  
info@ceramichelea.it  
www.ceramichelea.com

Panariagroup Industrie Ceramiche  
S.p.A.

SHOWROOM LEA CERAMICHE  
Via Durini, 3  
20122 Milano

Tel +39 02 76011406  
showroom\_milano@ceramichelea.it

LEA NORTH AMERICA, LLC  
800 Clanton Road, Suite N  
Charlotte, NC 28217

Tel +1 704 522 6300  
Fax +1 704 522 6080  
info@leausa.us  
www.leausa.us