

ARG ILLA TERRACQUE



ARG
ILLA
TERRACQUE

“Il chiarore dell'alba si apre nella nebbia filtrando attraverso il cielo coperto, i colori della terra appaiono desaturati con tonalità di grigio che li rende raffinati e omogenei.”

“The light of dawn breaks through the fog filtering into the overcast sky. Earthy colors have drained into shades of gray that make them more refined and uniform.”

La collezione **ARGILLA TERREACQUE** di Gigacer si ispira a questo paesaggio cromatico per poi concretizzarsi in materia per l'architettura con grandi e resistenti lastre in gres porcellanato di cm120x120 che da sempre rappresentano l'identità e la forza dell'azienda.

Gigacer ARGILLA TERREACQUE collection is inspired by chromatic landscapes which then are translated into materials for architecture. Large and resistant porcelain stoneware slabs, 120x120 cm, which have always been the company's strength and identity.

GIGACER

INDEX



INDEX

3 Introduction

6 COLLECTION

8 SURFACES

10 SIZES AND THICKNESSES

12 COLOURS

14 BIACCA

18 DRY

22 VETIVER

26 MARINE

30 FOG

34 DARK

38 PENTAGON

46 SPACES

56 AVANTIME CHROMATIC VISION SYSTEM

62 PRODUCT GUIDE

A landscape of colorful, eroded hills and a cracked, blue-tinted pool of water. The hills are layered with various shades of brown, tan, and white, showing signs of erosion. In the foreground, a large, cracked pool of water has a distinct blue tint. The ground around the pool is dry and cracked, with some small green plants growing. The overall scene is a natural, colorful landscape.

**LE TONALITÀ DEI COLORI
DELLA TERRA CAMBIANO
NEL CORSO DELLE ORE E
DELLE STAGIONI**

**THE COLOURS OF THE
GROUND CHANGE OVER
HOURS AND SEASONS**

ARGILLA TERREACQUE riscopre le espressioni più naturali delle terre faentine, le argille, creando una gamma cromatica dalla tonalità pastello, in cui la materia diventa protagonista.

ARGILLA TERREACQUE rediscovers the most natural expressions of the Faentinian lands, the clays, creating a chromatic range with a pastel shade, where the material becomes the main subject.



—
MATERIAL
—



—
QUARTZ
—

La superficie **MATERIAL** è opaca e al tatto presenta un lieve rilievo che ricorda un intonaco irregolare. Disponibile nello spessore sottile di ≈ 4.8 mm, è ideale per pavimentazioni e vibranti rivestimenti.

La superficie **QUARTZ** presenta una lucidatura molto naturale che ricorda i cementi levigati al quarzo. Disponibile nello spessore di ≈ 12 mm, è ideale per resistenti ed eleganti pavimentazioni di ambienti commerciali e residenziali.

MATERIAL surface is matte and reveals to the touch a slight relief, reminiscent of unfinished gypsum. Available in ≈ 4.8 mm thickness, it is ideal for floorings and vibrant coverings.

QUARTZ surface has a very natural brushed look, that recalls of buffed quartz cement. Available in ≈ 12 mm thickness, it is ideal for durable elegant floorings in both commercial and residential spaces.

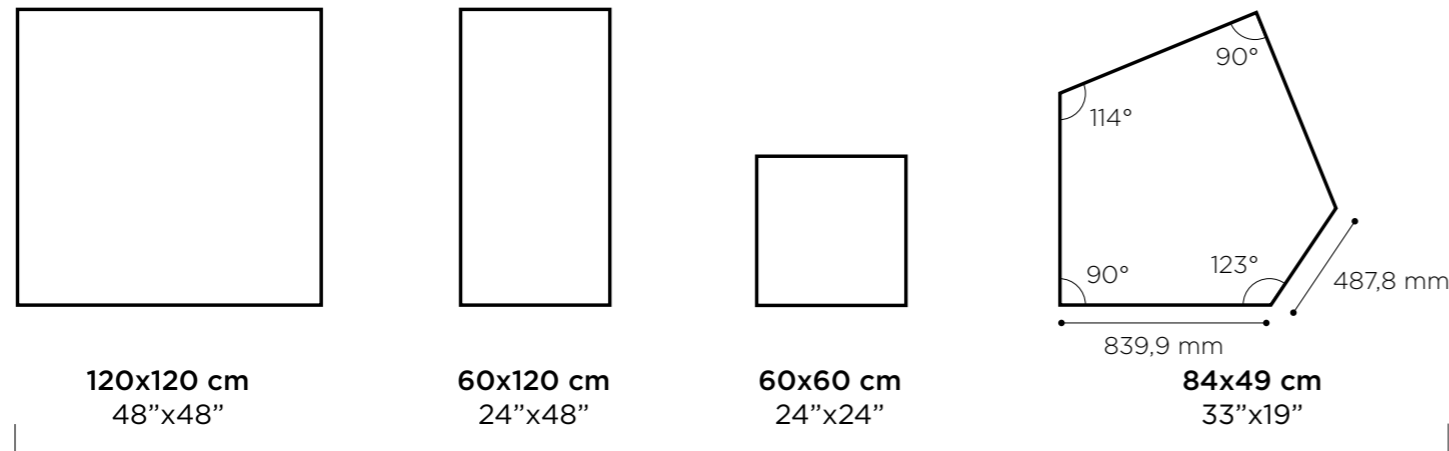

≈4.8 mm / 12 mm

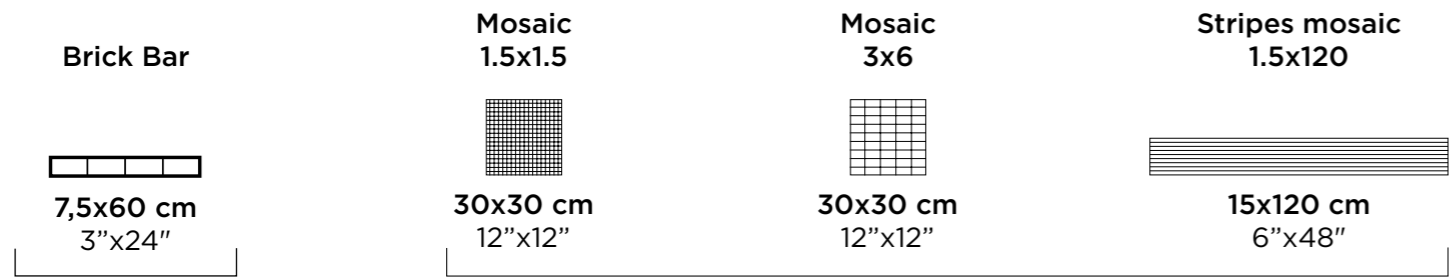

≈12 mm Playone

≈4.8 mm Playone

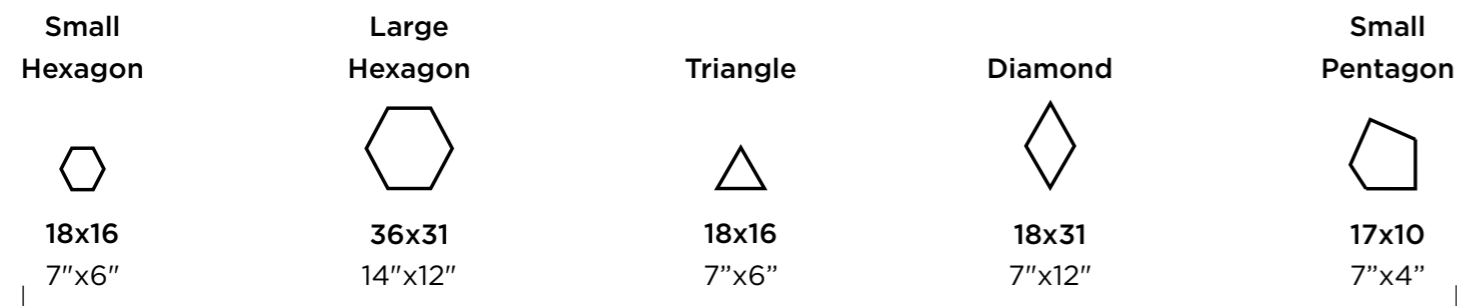

≈4.8 mm Playone

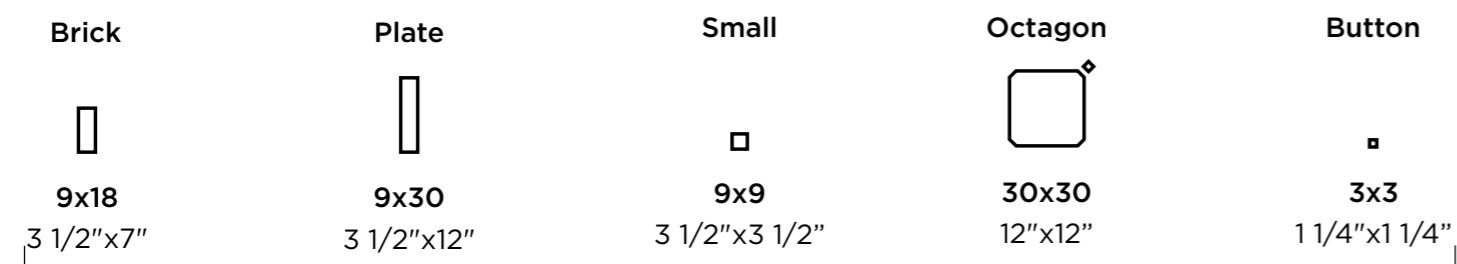

≈4.8 mm Playone



IL GRES PORCELLANATO DAL CARATTERE FORTE

- Grandi lastre 120x120 cm e sei diversi formati modulari
- Originale e inedito formato Pentagon
- Due spessori: ≈4,8 e ≈12 mm
- Superficie Material ≈4,8 mm per rivestimenti e pavimenti
- Superficie Quartz ≈12 mm per pavimenti
- Gres ingelivo, resistente a fuoco e sollecitazioni
- Decisa e autentica espressività materica
- Naturalità cromatica
- Per luoghi residenziali e commerciali

PORCELAIN STONEWARE WITH A STRONG CHARACTER

- 120x120 cm big size slabs in six modular formats
- Brand new Pentagon shape
- Two thicknesses: 4.8mm and 12mm
- Material surface in 4,8mm for floors and wall coverings
- Quartz surface in 12mm for floors
- Frostproof unglazed porcelain stoneware, with very high fire and mechanical resistance
- Genuine lines and textures
- Natural colours
- For residential and commercial applications

Le 6 tonalità di colore sono fra loro affini, interpretate da due diverse superfici: QUARTZ per pavimenti e MATERIAL per rivestimenti e pavimentazioni. Il grigio DRY e il chiaro BIACCA, colori moderni e raffinati, ricordano la presenza di una vena del gesso, determinando una tendenza fredda e rocciosa. Il marrone FOG e il bruno DARK, si presentano con tonalità più calde richiamando le argille più superficiali. VETIVER e MARINE completano la collezione con il riferimento all'acqua, naturale compendio della terra.

These 6 colours shades are available on two different surfaces: QUARTZ for flooring and MATERIAL for both floor and wall applications. The DRY grey and the BIACCA clear, modern and refined colors, recall the presence of a vein of chalk, determining a cold and rocky trend. FOG brown and DARK brown are presented in warmer tones recalling the more superficial clays. VETIVER and MARINE complete the collection with reference to water, the natural compendium of the earth.





01

BIACCA



1



2

**Il bianco totale a parete e a terra accentua il valore espressivo delle forme.
Due diverse superfici interpretano il medesimo colore.**

All white walls and flooring accentuate the expressive value of any form.
Two different textures interpret the same colour.

1. / 2.

PAVIMENTO | FLOOR:

Argilla Biacca Quartz 120x120 / 48"x48" / #12 mm

PARETE | WALL:

Argilla Biacca Material 120x120 e 60x120 / 48"x48" and 24"x48" / #4.8 mm



02

DRY



1



2

Il design moderno di Argilla è incentrato su progettualità e coordinamento fra pavimento e rivestimento.

The modern design of Argilla is centered around the planning and coordination between floor and wall coverings.

1. / 2.

PAVIMENTO | FLOOR:
Argilla Dry Quartz 120x120 / 48"x48" / ≠12 mm

PARETE | WALL:
Argilla Dry Material 120x120 / 48"x48" / ≠4.8 mm



03

VETIVER



Legni, bamboo, accenti metallici ed essenze profumate danno vita a eleganti ambienti.

Wood, bamboo, metallic accents and fragrant scents give life to any elegant setting.

1. / 2.

PAVIMENTO | FLOOR:

Argilla Vetiver Quartz 120x120 / 48"x48" / ±12 mm

PARETE | WALL:

Argilla Vetiver Material 120x120 / 48"x48" / ±4.8 mm



04

MARINE



Il pensiero progettuale di Gigacer si rivolge ad un abitare personalizzato con prodotti ceramici altamente tecnologici, sempre meno seriali e decisamente più proiettati sui nuovi stili di vita.

Gigacer's design concept caters to a personalized living space using high-tech ceramic products which are less and less standardized and distinctly created keeping in mind today's modern lifestyle

1. / 2.

PAVIMENTO | FLOOR:

Argilla Marine Quartz 120x120 / 48"x48" / ±12 mm

PARETE | WALL:

Argilla Marine Material 120x120 / 48"x48" / ±4.8 mm



05

FOG



1



2

Luci e ombre raccontano un'intima scenografia abitativa, avvolta in una resistente materia ceramica.

Lights and shadows narrate an intimate residential setting, wrapped in durable ceramic material.

1. / 2.

PAVIMENTO | FLOOR:
Argilla Fog Quartz 120x120 / 48"x48" / ±12 mm

PARETE | WALL:
Argilla Fog Material 120x120 / 48"x48" / ±4.8 mm



06

DARK



1



2

**Lastre ceramiche 120x120 Material in soli \approx 4,8 mm di spessore.
Leggere, versatili, forti, resistenti e dotate di straordinaria naturalezza materica,
ideali per tutti gli spazi abitativi.**

120x120 Material ceramic slabs only \approx 4.8 mm in thickness.
Light, versatile, strong, durable and extraordinarily natural, ideal for all living spaces.

1. / 2.

PAVIMENTO | FLOOR:

Argilla Dry Quartz 120x120 / 48"x48" / \approx 12 mm

PARETE | WALL:

Argilla Dark Material 120x120 / 48"x48" / \approx 4.8 mm

PENTAGONO
PENTAGON

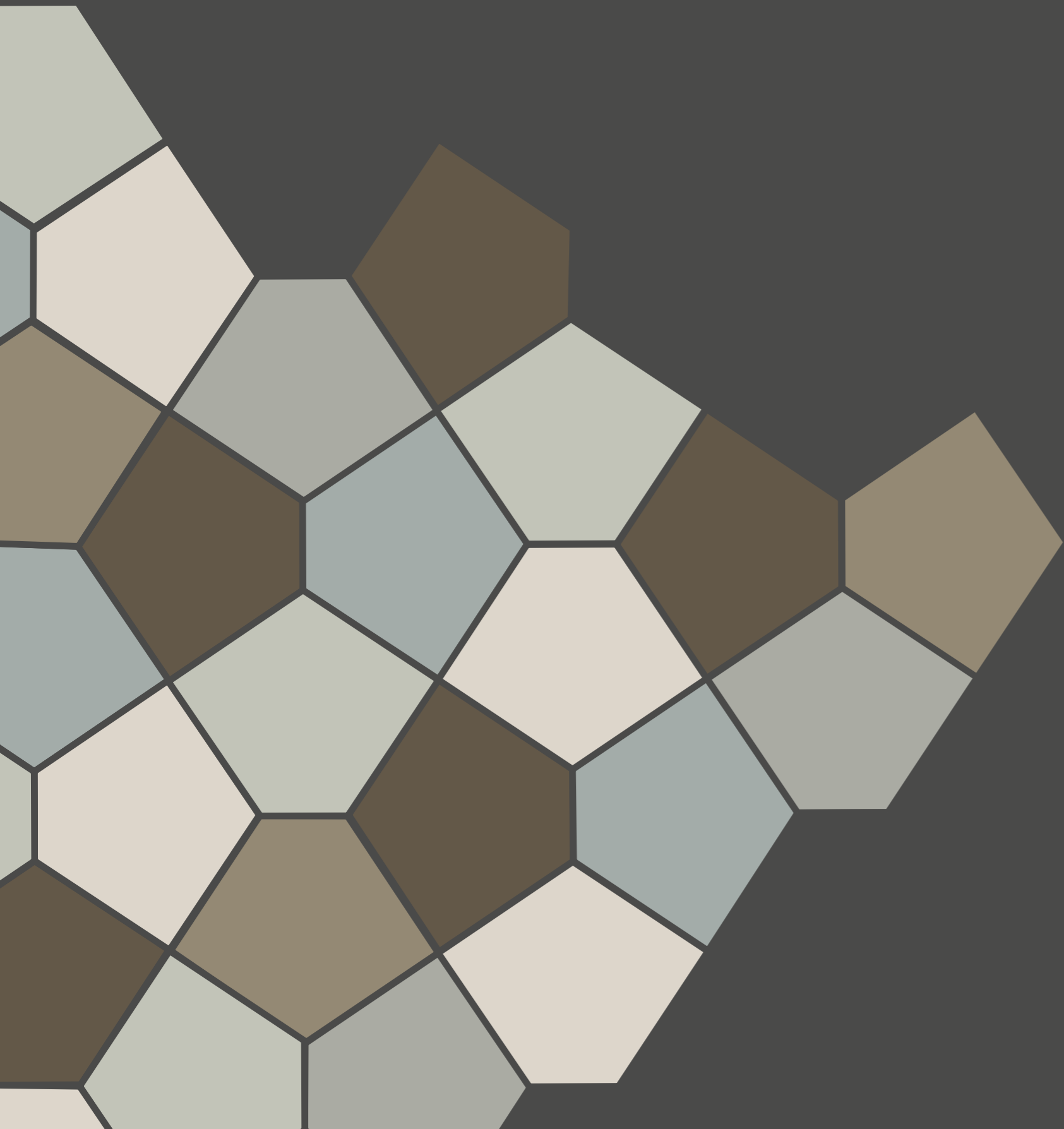

Una inedita forma geometrica dedicata all'architettura.

An innovative geometric shape dedicated to architecture.

PENTAGON PENTAGONO

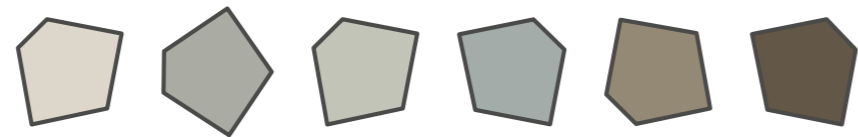

BIACCA DRY VETIVER MARINE FOG DARK

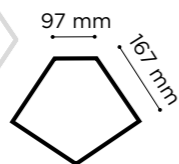
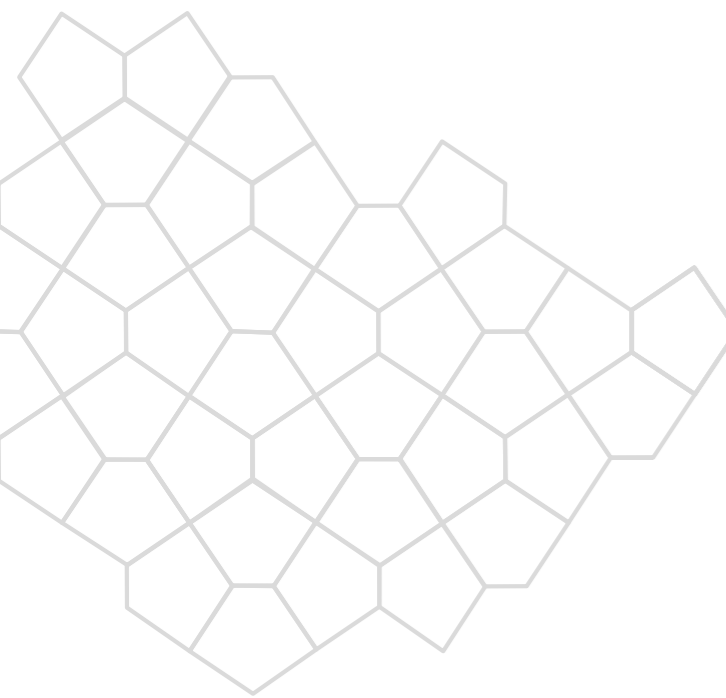

SMALL PENTAGON
- MATERIAL \neq 4.8MM

LARGE PENTAGON
- MATERIAL \neq 4.8MM
- QUARTZ \neq 12MM

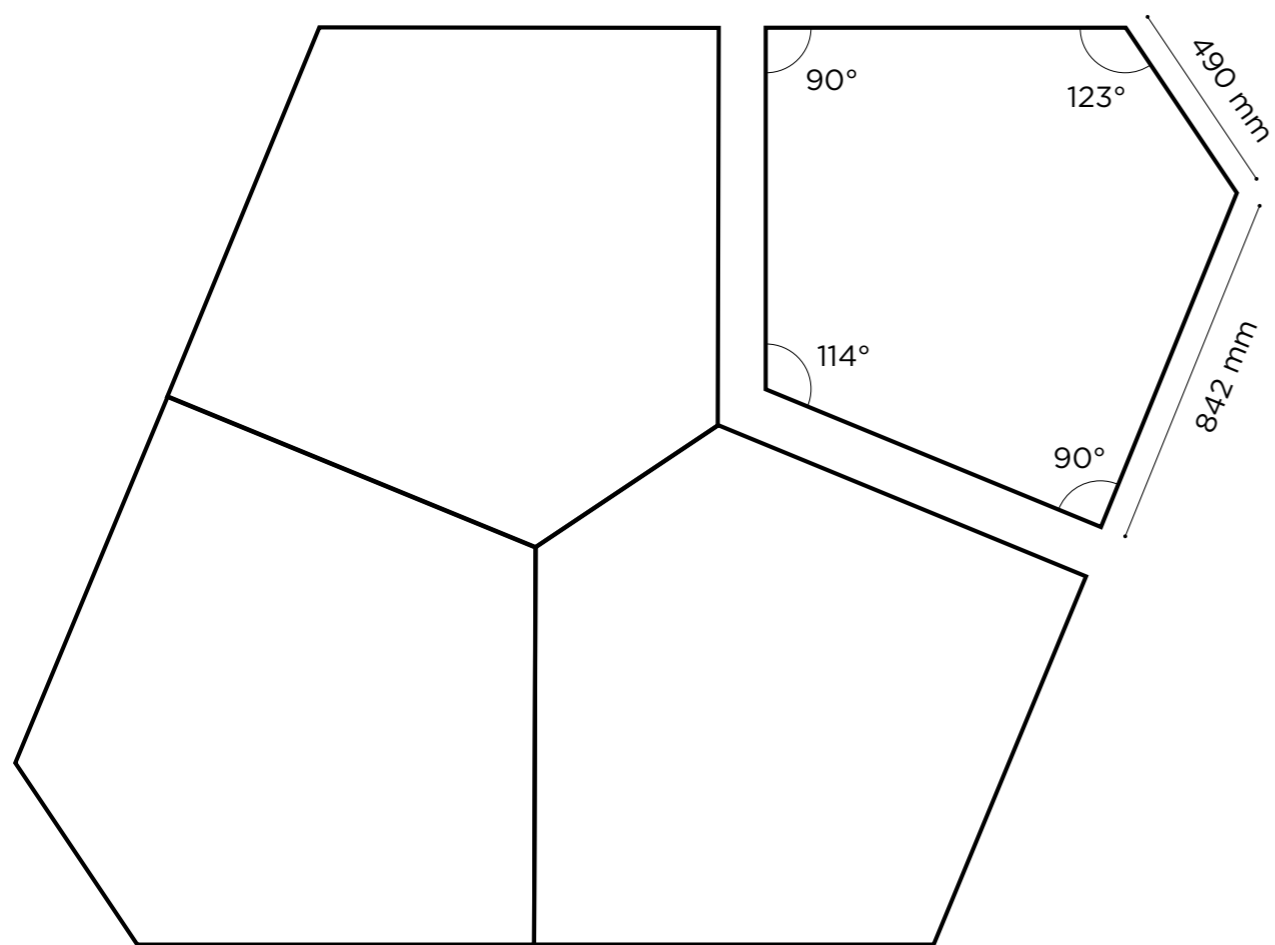

ARGILLA TERREACQUE





PAVIMENTO | FLOOR:
Argilla Large Pentagon / Fog Material / Biacca Material / Dry Material 84x49 / 33"x19" / 4.8 mm



1



2

Small Pentagon a rivestimento è un invito alla creatività con combinazioni originali che ricordando le naturali spaccature dell'argilla.

Small Pentagon for wall finishing is an invitation to creativity with original combinations that remind us of natural clay cracks.

1. / 2.

PAVIMENTO | FLOOR:
Argilla Marine Quartz 60x60 / 24"x24" / 12 mm

PARETE | WALL:
Small Pentagon Argilla Marine e Biacca Material 17x10 / 7"x4" / 4.8 mm

PIANO | TOP:
Concrete White 12 mm Gigacer Service
ANTE | CABINETS DOOR:
Concrete Graphite 6 mm Gigacer Service



AMBIENTI
SPACES

Il racconto della collezione **ARGILLA TERRE ACQUE** si snoda intorno a diversi set abitativi interpretati da poetici still-life d'autore.

This chronicle of the **ARGILLA TERRE ACQUE** collection, as interpreted by poetic signature still-lifes, winds its way through various urban settings.



1



2

1. / 2.
PAVIMENTO | FLOOR:
Argilla Fog Material 120x120 / 48"x48" / ≠4.8 mm
DETTAGLIO PARETE | WALL DETAIL:
Argilla Dark Material Mosaic 6x3 / 30x30 / 12"x12" / ≠4,8 mm
PIANO DEI TAVOLINI | COUNTER TOP COFFEE TABLE
All Argilla Colours Material / ≠4.8 mm / **Gigacer Service**
BANCONI | COUNTER
Concrete Black / Gigacer Service



3



4

3. / 4.
PAVIMENTO | FLOOR:
Argilla Dry Material 60x60 / 24"x24" / \approx 4.8 mm



PAVIMENTO | FLOOR:
Argilla Vetiver Material Stripes Mosaic 15x120 / 6"x48" / ±4.8 mm
PARETE | WALL:
Argilla Vetiver Material 60x120 / 24"x48" / Argilla Vetiver Material Stripes Mosaic 15x120 / 6"x48" / ±4.8 mm



PAVIMENTO | FLOOR:
Argilla Vetiver Material 120x120 / 48"x48" / ≠4.8 mm / **Argilla Vetiver Material Stripes Mosaic** 15x120 / 6"x48" / ≠4.8 mm
PARETE | WALL:
Argilla Vetiver Material Mosaic 1.5x1.5 / 30x30 / 12"x12" / ≠4.8 mm
LAVABO MIDDLE | MIDDLE WASHBASIN:
Argilla Vetiver Material 119x50 / 48"x19 1/2" / ≠4.8 mm

AVANTIME
CHROMATIC VISION
SYSTEM

ISOLA | ISLAND:
Small Pentagon Argilla Marine e Biacca Material 17x10 / 7"x4" / 4.8 mm
PIANO | TOP:
Concrete White 12 mm / Gigacer Service
ANTE | CABINETS DOOR:
Concrete Graphite 6 mm / Gigacer Service
PAVIMENTO | FLOOR:
Argilla Marine Quartz 60x60 / 24"x24" / 12 mm

GIGACER offre un'inedita gamma di formati, spessori e colori naturali per progettare ogni tipo di superficie: pavimenti e rivestimenti, spazi residenziali e commerciali, indoor e outdoor, mobili, facciate ventilate e piscine. Uno strumento duttile e ricco di soluzioni per il progetto architettonico.

GIGACER ha ideato Avantime 'a new vision for architecture': un nuovo modo di vedere e interpretare un brand ceramico. Avantime è un innovativo sistema di lastre ceramiche incentrato su colori, formati, mosaici e decori. Avantime unisce in modo trasversale tutte le collezioni GIGACER regalando effetti e abbinamenti unici e originali, grazie alla filosofia di prodotto mantenuta costante e univoca nel tempo.

Nel progetto architettonico il colore è determinante per la scelta dei materiali per pavimentazioni e rivestimenti, nasce così Chromatic Vision, un'inedita gamma cromatica comprensiva di tutte le collezioni GIGACER che le ripropone secondo una logica ispirata a varie scale cromatiche e tonali.

GIGACER offers an outstanding range of formats, thicknesses and natural colours in order to design any type of surface: floors and walls, residential and commercial spaces, indoor and outdoor, furniture, ventilated facades and swimming pools. A ductile tool full of solutions for the architectural project.

Avantime is an innovative ceramic slabs' system focused on colours, formats, mosaics and decors. Avantime joins in a transversal way all the GIGACER collections, offering effects and unique and original matching thanks to the product philosophy kept constant and univocal over time.

In the architectural project, the colour is important for the choice of the materials for surface and covering; for this reason the Chromatic Vision born, an outstanding chromatic range including all the GIGACER collection, which proposes them following a logic inspired by various chromatic and tonal scales.



1



2

1.
PARETE | WALL:
Déco Arctic 120x250 / 48"x100" / ≠6 mm / **Concrete Pure** 60x250 / 24"x100" / ≠6 mm
PAVIMENTO | FLOOR:
Argilla Vetiver Material 120x120 / 48"x48" / ≠4.8 mm
2.
PARETE | WALL:
Déco Mountain 120x250 / 48"x100" / ≠6 mm
PAVIMENTO | FLOOR:
Argilla Material Fog 120x120 / 48"x48" / ≠4.8 mm



3



4

3.

PARETE | WALL:

Light 250 Curtain 120x250 / 48"x100" / ≠6 mm

PAVIMENTO | FLOOR:

Argilla Vetiver Material 120x120 / 48"x48" / ≠4.8 mm

4.

PARETE | WALL:

Krea Blue 120x120 / 48"x48" / ≠4.8 mm

PAVIMENTO | FLOOR:

Argilla Marine Quartz 120x120 / 48"x48" / ≠12 mm

GUIDA PRODOTTO
PRODUCT GUIDE

ARGILLA TERREACQUE

SOSTENIBILITÀ SUSTAINABLE THINKING	64
FORMATI E SPESSORI SIZES AND THICKNESSES	66
SUPERFICI E COLORI SURFACES AND COLOURS	67
PLAYONE	68
PEZZI SPECIALI SPECIAL TRIMS	70
GIGACER SERVICE	71
LAVABI E PIATTI DOCCIA WASHBASINS AND SHOWER TRAYS	72
DESTINAZIONI D'USO INTENDED USE CLASSIFICATION	74
SUGGERIMENTI PER LA POSA INSTALLATION SUGGESTION	74
INDICE DI STONALIZZAZIONE SHADE VARIATION INDEX	75
CALIBRI CALIBERS	75
CARATTERISTICHE TECNICHE TECHNICAL SPECIFICATION	75
NOTE TECNICHE TECHNICAL NOTES	76
IMBALLI PACKAGING	78
CERTIFICAZIONI CERTIFICATIONS	79

SOSTENIBILITÀ

Curiamo con particolare attenzione:

- la sicurezza ed il comfort del personale addetto alla produzione;
- il rispetto dell'ambiente in cui sorge lo stabilimento;
- la sicurezza del personale sul cantiere, garantita da imballaggi studiati per facilitare la movimentazione e completamente riciclabili.

Produciamo grandi lastre ceramiche grazie all'applicazione di tecnologie all'avanguardia, nel rispetto (spesso anche in senso molto migliorativo) delle vigenti normative europee sull'ambiente. Per questo i macchinari si trovano in ambienti insonorizzati, l'illuminazione della linea produttiva è a basso regime, esiste un monitoraggio ambientale in tempo reale, il sistema di imballaggio - sidepack - prevede, prima della pressatura, l'utilizzo di quantità di cartone minime e comunque i materiali dell'imballo sono completamente riciclabili e privi di colle.

La nuova lastra sottile 4.8 è di fatto il nuovo orizzonte del risparmio energetico in ceramica: offre la possibilità di produrre gres porcellanato di altissima qualità con notevole risparmio di energia sia durante il processo di cottura sia durante il trasporto.

INNOVAZIONE TECNOLOGICA

Un processo produttivo intelligente.

Il processo produttivo di GIGACER prevede la preparazione preliminare di un unico formato, grandi lastre in gres porcellanato 120x120 cm, multistrato a tutta massa, che possono essere successivamente tagliate e modificate a freddo in molteplici altri formati e superfici mantenendo la massima garanzia di requisiti tecnici qualitativi ed estetici.

Questa serie di lastre caratterizzate da superiori prerogative tecniche ed estetiche viene prodotta in gres porcellanato a tutta massa multistrato con una tecnologia assolutamente innovativa. L'impianto è stato progettato appositamente per produrre grandi formati e utilizza la tecnologia definita "CONTINUA" che prevede prima della pressatura, una fase di precompattazione della lastra multistrato a tutta massa che permette di ottenere speciali effetti decorativi senza ricorrere all'uso di smalti, ma solo con la distribuzione di impasti porcellanati colorati di qualità. Gli spessori delle lastre prodotte sono di 12 mm e 4.8 mm.

SUSTAINABLE THINKING

We pay close attention to:

- the safety and comfort of our production staff;
- the respect for the environment in and around the factory;
- the safety of tile layers in the building site, which is guaranteed by the specially designed packaging that makes movement easier and that is completely recyclable.

We manufacture large porcelain slabs thanks to the application of advanced technologies, in accordance with the current European environmental standards (and often with even better results). For this reason the engines are installed in soundproof areas, the lighting around the production area is low emission, there is an environmental monitoring in real time, the complete packaging (sidepack) uses minimum quantities of cardboard and, however, the material used for packaging is completely recyclable and glueless.

The new 4.8 thin slab is in fact the most advanced system concerning energy saving: it give us the possibility of manufacturing high quality porcelain stoneware tiles with a remarkable energy saving, both for firing and carriage.

TECHNOLOGICAL INNOVATION

An intelligent production process.

GIGACER production process starts from large porcelain slabs, size 120x120 cm, homogeneous multilayer. The slabs can then be cut in many other submultiples and worked again to get different finishes, preserving their top quality and aesthetic features.

These homogeneous multilayer porcelain slabs show superior technical and aesthetical characteristics thanks to a highly innovative technology. The equipment has been realized on purpose to manufacture large sizes and uses an innovative technology called "CONTINUA". This technology foresees a pre-compacting phase before pressing, that allows to achieve special decorative effects without using glazes, but only distributing the porcelain mixed powders on the body. The thickness of the manufactured slabs are 12 mm and 4.8 mm.



FORMATI E SPESSORI SIZES AND THICKNESSES

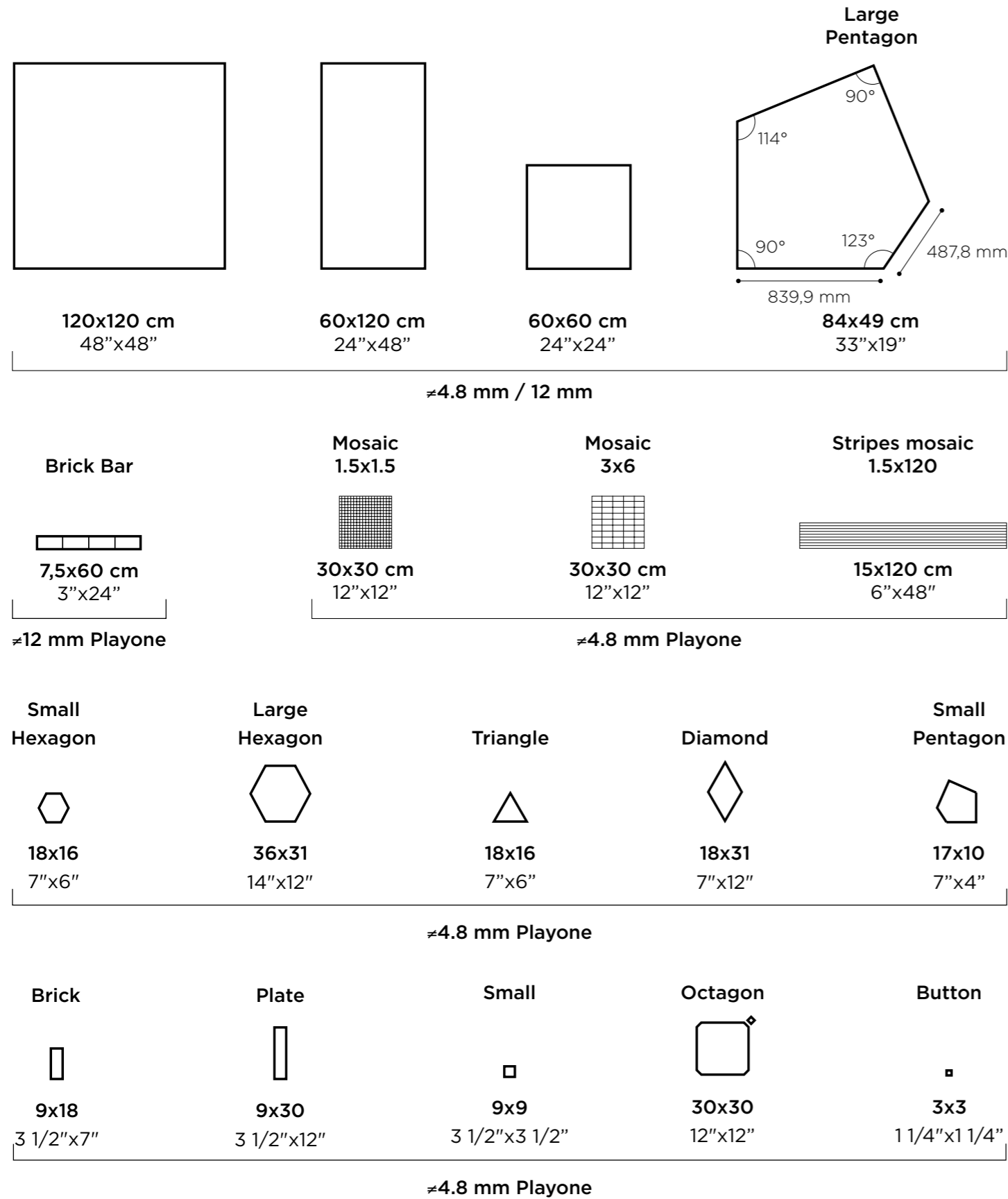

SUPERFICI E COLORI SURFACES AND COLOURS



MATERIAL
è disponibile in
is available in
≈ 4.8 mm

QUARTZ
è disponibile in
is available in
≈ 12 mm

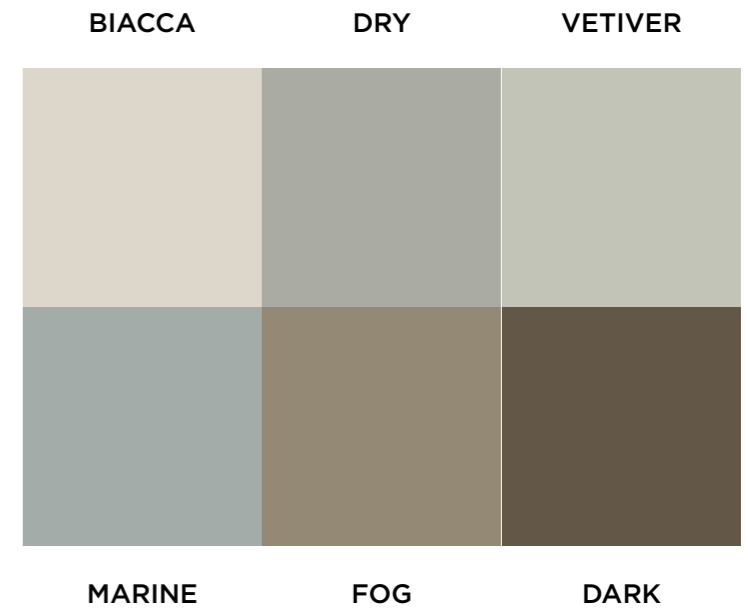

PEZZI SPECIALI PLAYONE
PLAYONE SPECIAL TRIMS

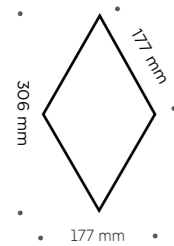

DIAMOND
18x31
7"x12"
≈4.8 mm

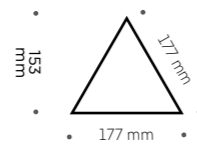

TRIANGLE
18x16
7"x6"
≈4.8 mm



BRICK
9x18
3 1/2"x7"
≈4.8 mm

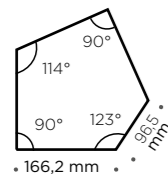

SMALL PENTAGON
17x10
7"x4"
≈4.8 mm

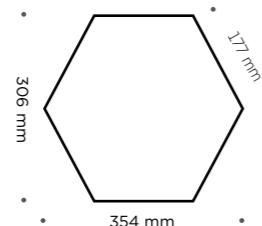

LARGE HEXAGON
36x31
14"x12"
≈4.8 mm

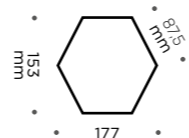

SMALL HEXAGON
18x16
7"x6"
≈4.8 mm

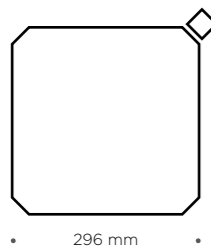

OCTAGON
30x30 cm
12"x12"
≈4.8 mm

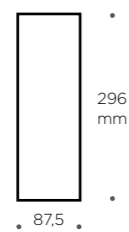
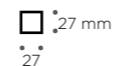

PLATE
9x30 cm
3 1/2"x12"
≈4.8 mm



SMALL
9x9 cm
3 1/2"x3 1/2"
≈4.8 mm



BUTTON
3x3 cm
1 1/4"x1 1/4"
≈4.8 mm

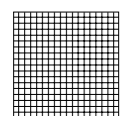

MOSAIC 1.5x1.5
30x30 cm
12"x12"
≈4.8 mm

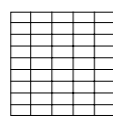

MOSAIC 3X6
30x30 cm
12"x12"
≈4.8 mm



MOSAIC 1.5x120
15x120 cm
6"x48"
≈4.8 mm

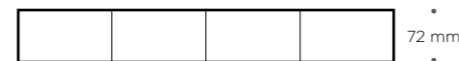

BRICK BAR
7,5x60 cm
3"x24"
≈12 mm



PEZZI SPECIALI SPECIAL TRIMS

BATTISCOPIA SKIRTING

Battiscopa 60
≈12mm

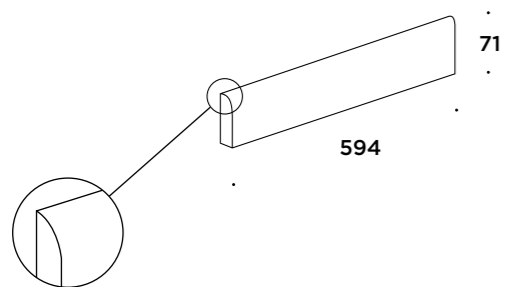

Battiscopa 120
≈4.8mm

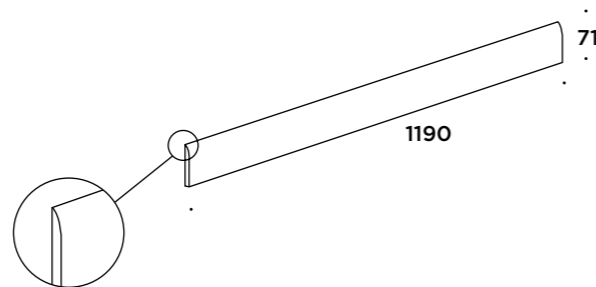

GRADONI COSTA RETTA COSTA RETTA STEPTREADS

Costa retta 60

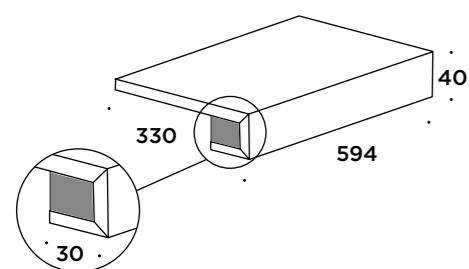

Costa retta 120

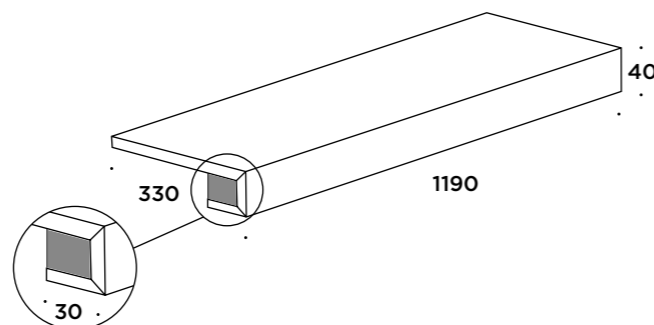

UTILIZZO

- Gradini per scale
- Davanzali
- Finitura terrazze e balconi
- Bordo piscine
- Interno o esterno

USE

- Steptreads for stairs
- Windowsills
- Terraces and balconies edge finish
- Poolside
- Indoor or outdoor

(!)
Tutte le misure sono in millimetri
All sizes are in millimetres

SERVIZI SPECIALI SPECIAL SERVICES

MODIFICHE SU RICHIESTA CHANGES ON REQUEST

È possibile richiedere la fattibilità e la quotazione per le seguenti modifiche:

- top squadrato invece che arrotondato
- top non smaltato (nel 12mm sarà visibile il multilayer)
- misure non standard: indicare misura X e Y in mm

It is possible to require the feasibility and the quotation for the following changes:

- squared top edge, instead of rounded
- unglazed top edge (on 12mm thickness the multilayer will be visible)
- bespoke sizes: please indicate X and Y in mm.

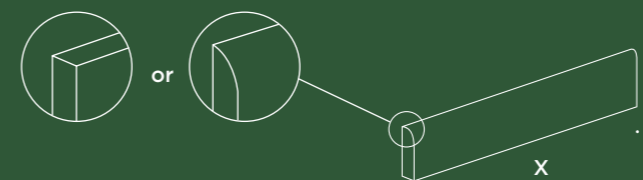

Le misure X, Y, Z e J sono modificabili a piacimento. Misura minima 30mm, massima 1900 per ogni variabile.

È possibile richiedere il gradone con chiusura su un lato o su entrambi, nel caso la scala sia aperta. Il pezzo può essere realizzato anche a vela senza rientranza. È necessario indicare tutte le misure richieste (A, B e C).

It is possible to request bespoke sizes on X, Y, Z and J. Minimum size 30mm, maximum 1900 for each variable.

It is possible to ask for one or both sides closed, if the staircase is open. The piece can be made without nose, only at 90°. All sizes must be specified (A, B and C).

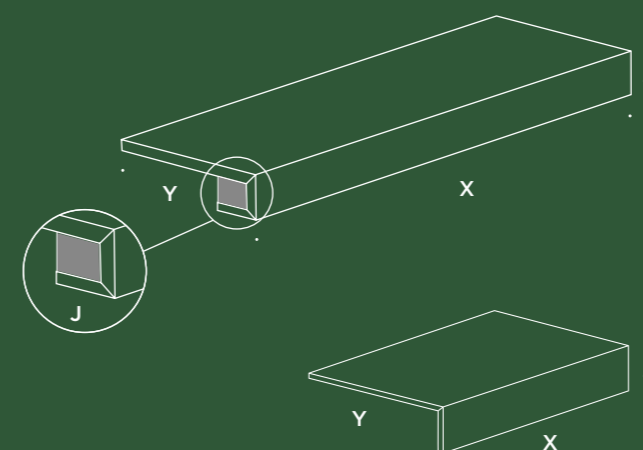

Gigacer Service è il servizio di lavorazioni su misura offerto da Gigacer su tutti i suoi prodotti. Consente di tagliare, forare, lucidare e in generale adattare le lastre al singolo progetto, seguendo le indicazioni di uno specifico disegno del cliente. In questo modo le lastre ceramiche possono essere utilizzate sia per realizzare elementi d'arredo, sia per personalizzare o adeguare al progetto le dimensioni di lastre per pavimento o rivestimento. Il pavimento o il rivestimento potrà così essere abbinato o addirittura identico al top cucina, ai gradini della scala, al top bagno o anche allo stesso lavabo, in una infinità possibilità di forme e dimensioni. Il pezzo unico viene realizzato anche seguendo le indicazioni e il disegno tecnico del progettista.

Gigacer Service is the firm's made to measure working service offered on all products. It enables slabs to be cut, perforated, polished and generally adapted to the individual project in line with the requisites of a specific client design. In this way the ceramic slabs can be used both to create decor elements and to personalise or adjust slab dimensions to flooring or decor designs. In this way the ceramic slabs can be matched with, or even identical to, the kitchen worktop, flights of steps, the bathroom worktop and even the basin in an infinity of possible forms and dimensions. Each single piece can be made in accordance with designers' instructions and technical drawings.

LAVABI E PIATTI DOCCIA WASHBASINS AND SHOWER TRAYS

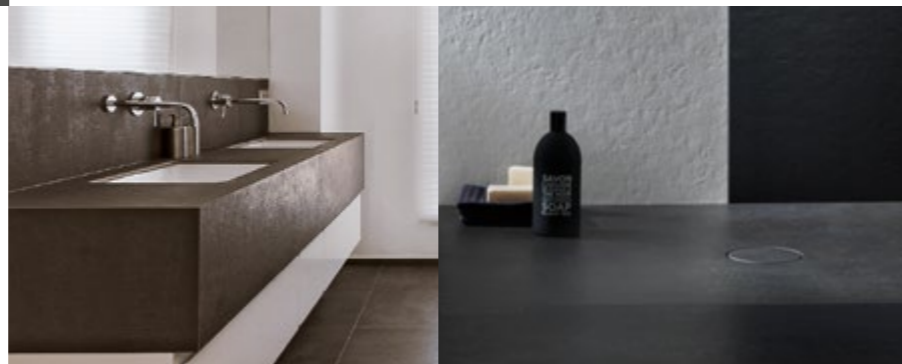

LAVABI WASHBASINS

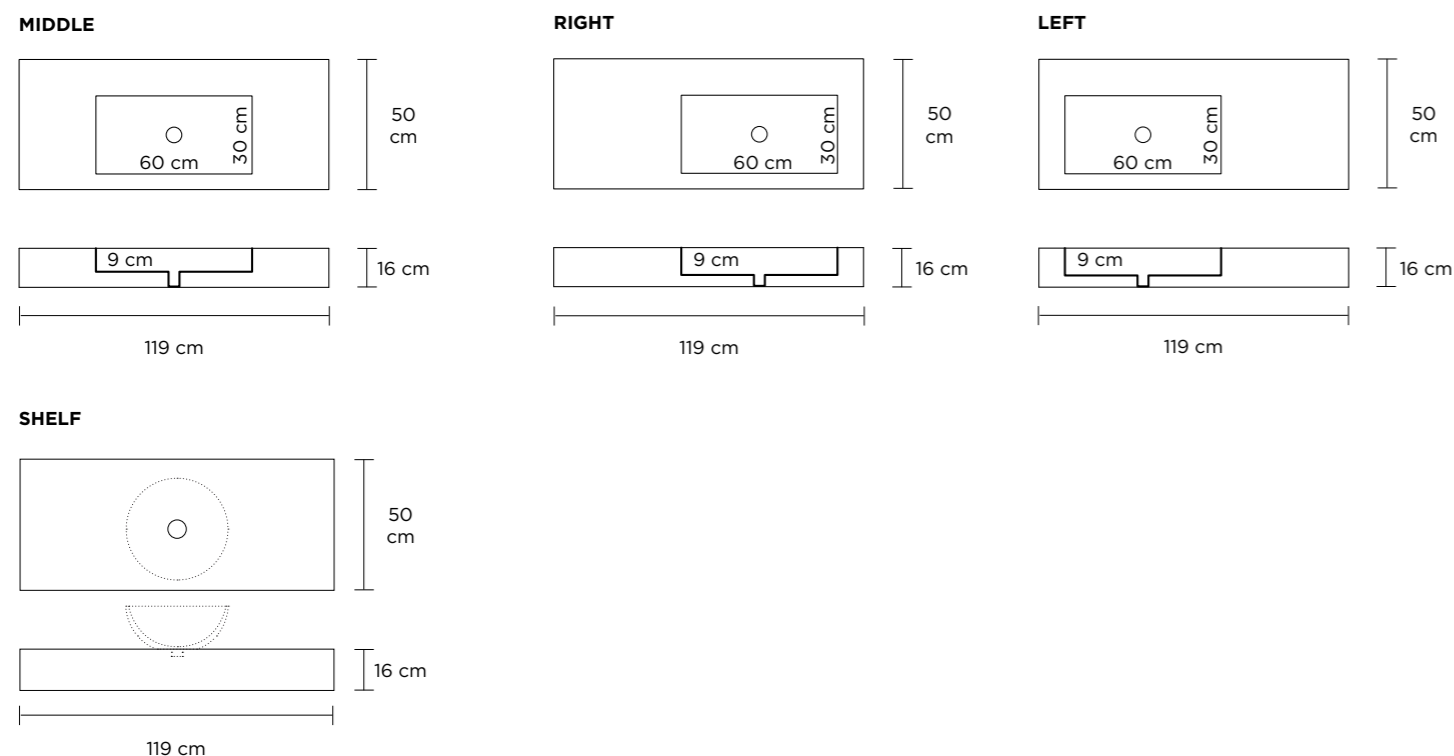

COLORE COLOUR	MODELLO MODEL	FORMATO CM SIZE
Tutti i colori Argilla Material All Argilla Material colours	MIDDLE	119x50 48"x19 1/2" ±4.8mm
Tutti i colori Argilla Material All Argilla Material colours	LEFT OR RIGHT	119x50 48"x19 1/2" ±4.8mm
Tutti i colori Argilla Material All Argilla Material colours	SHELF senza lavabo / without washbasin	119x50 48"x19 1/2" ±4.8mm
	SHELF con lavabo / with washbasin	

PIATTI DOCCIA SHOWER TRAYS

MODELLO A

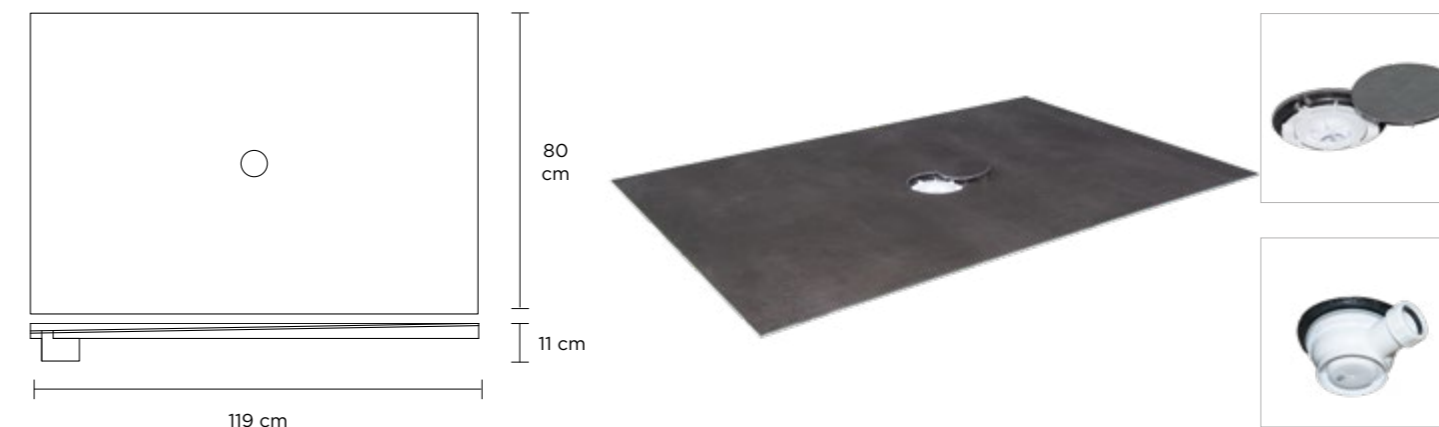

MODELLO B

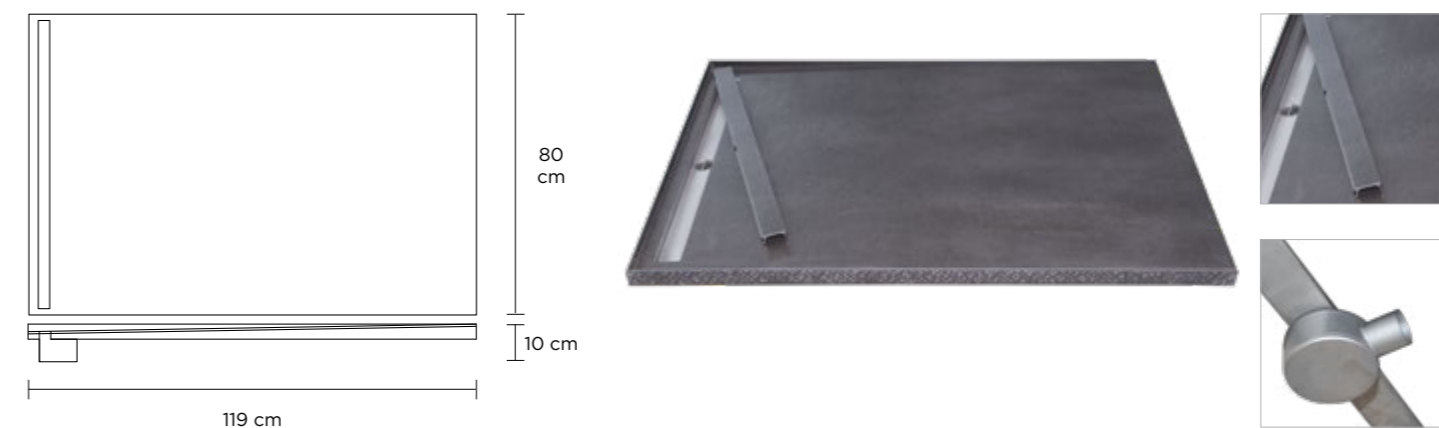

COLORE COLOUR	MODELLO MODEL	FORMATO CM SIZE
Tutti i colori Argilla Material All Argilla Material colours	A (termoformato / thermoformed)	119x80 48"x31 1/2" ±4.8mm
Tutti i colori Argilla Material All Argilla Material colours	B (assemblato / assembled)	119x80 48"x31 1/2" ±4.8mm
Tutti i colori Argilla Material All Argilla Material colours	Canalina rivestita / Drain System Shower tray made with tile 	70x7 27 1/2"x3" ±4.8mm

Tutte le informazioni tecniche inerenti ai lavabi e ai piatti doccia le puoi trovare sulla brochure "Gigacer Service" e sul sito www.gigacer.it / You can find all technical information about washbasins and shower trays in our brochure "Gigacer Service" and on our web site www.gigacer.it.

DESTINAZIONI D'USO INTENDED USE CLASSIFICATION

	PAVIMENTI NUOVE COSTRUZIONI	PAVIMENTI IN RISTRUTTURAZIONI	RIVESTIMENTI	COMMERCIALE LEGGERO	COMMERCIALE PESANTE	ESTERNI	SOPRELEVATO	PIANI DI LAVORO
	NEW FLOORS	FLOOR RENOVATION	WALL COVERING	LIGHT COMMERCIAL	HEAVY COMMERCIAL	OUTDOOR	RAISED FLOOR	COUNTERTOPS AND KITCHENTOPS
4.8 mm	+	++	++	+	--	-	--	-
12 mm multilayer	++	+	+	++	++	+	+	-
	Posa a terra in nuove costruzioni su massetto.	Posa a terra su pavimenti esistenti, in ceramica o pietra naturale, o su massetto in costruzioni in stato di ristrutturazione.	Rivestimento muri.	Ambienti pubblici interni a medio traffico.	Ambienti pubblici interni ad alto traffico.	Ambienti esterni.	Pavimenti soprelavati con struttura flottante o posa su supporti in PVC.	
	Floor tiling on screed in new buildings.	Floor tiling on screed or on existing floor (in ceramic or natural stone) in buildings under renovation.	Wall covering.	Indoor public places subject to medium pedestrian traffic.	Indoor public places subject to heavy pedestrian traffic.	Outdoor places.	Raised floor with floating structure or PVC supports.	

++ Consigliato Recommended
+ Appropriato Suitable

- Non consigliato Not recommended
-- Non appropriato Not suitable

SUGGERIMENTI PER LA POSA INSTALLATION SUGGESTION

Le lastre di 4,8 mm sono: resistenti, sottili, leggere, facili da movimentare e da tagliare, resistenti al fuoco, ingelive, ecocompatibili e non necessitano di particolari accorgimenti per la manutenzione. È un prodotto ideale per pavimenti e rivestimenti interni ed esterni, ed è particolarmente adatto nel caso di ristrutturazione di pavimentazioni e rivestimenti residenziali: si applica sull'esistente senza opere di demolizione e relativi costi di smaltimento. Il nostro porcellanato sottile è abbinabile ai pavimenti con 2 mm di fuga della stessa collezione in spessori diversi, dei quali mantiene non solo le stesse caratteristiche estetiche, ma anche il medesimo calibro e modularità. Il 4,8 mm è un prodotto dal design ecologico: lo spessore ridotto comporta un minor impatto ambientale in termini di consumo di energia, materie prime, imballo e trasporti. Costituisce una valida alternativa al gres porcellanato di spessore tradizionale in tutti i casi in cui il minor spessore e la leggerezza costituiscono un fattore determinante. In fase di posa, le lastre di spessore 4,8 mm risultano perfettamente complanari.

SUGGERIMENTI PER LA POSA

INCOLLAGGIO: Doppia spalmatura (sul fondo e sul retro della piastrella).

TAGLIO: Normale taglierina da cantiere, sega a dischi diamantati.

FORATURA: trapani a punta per gres porcellanato, frese a tazza, idrogetto. Non usare il percussore e raffreddare con acqua nel punto di contatto.

4,8 mm slabs are resistant, thin, lightweight, easy to handle and cut, fire-resistant, frostproof, environmentally friendly and require no special care for maintenance. 4,8 mm is an ideal product for interior and exterior cladding. 4,8 mm slabs are particularly suitable in the case of renovation of residential floors and walls: they can be laid on the existing floor, allowing for a dramatic demolition and disposal cost savings. GIGACER 4,8 mm is suitable for indoor and outdoor wall covering and it is particularly indicated in all cases where it is preferable not to load too much weight on the building's structure. 4,8 mm can be combined with the 12 mm slabs of every collection because it has the same caliber and it is perfectly modular with 2 mm joints. 4,8 mm is a green product: it allows savings in terms of energy consumption, raw materials, packaging and transport. It is a valid alternative to the traditional 12 mm in all those cases where lightness and less thickness represent a determinant variable. 4,8 mm tiles can be fixed together on the same surface, as the real difference in thickness is minimal.

INSTALLATION SUGGESTIONS

GLUING: Double spreading (on substrate and on the back of the tile)

CUTTING: Standard dry diamond clipper for porcelain tiles, bench machines with diamond disks.

DRILLING: Drills with porcelain drill tips, hollow mills or hose-mounted drill bits (for large size holes), hydrojet. Never use the hammer function when drilling, and cool with water while drilling.

INDICE DI STONALIZZAZIONE SHADE VARIATION INDEX

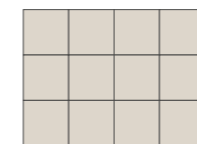

V1 / LOW
Prodotto monocromatico
Monochromatic product

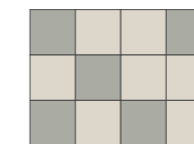

V2 / MODERATE
Prodotto con leggera variazione cromatica / Product with light chromatic variation

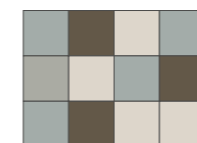

V3 / HIGH
Prodotto con marcata variazione cromatica / Product with high chromatic variation

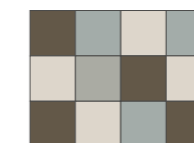

V4 / VERY HIGH
Prodotto con forte variazione cromatica / Product with very high chromatic variation

	SUPERFICE SURFACES	STONALIZZAZIONE SHADE VARIATION
ARGILLA	Material / Quartz	V1
	Material / Mosaics	V3
	Material / Quartz Pentagon	V3

CALIBRI CALIBER

Le nostre lastre sono sempre rettificate e hanno dimensioni finali in millimetri come da tabella. Il calibro standard è lo 09 e i formati dello stesso calibro multipli tra loro sono modulari con 2 mm di fuga.

Our slabs are always rectified and the table below indicates their final size in millimetres. Our standard caliber is 09 and all sizes with the same caliber, when multiples, are modular with 2 mm joint spacing.

FORMATO NOMINALE (CM) NOMINAL SIZE (CM)	FORMATO RETTIFICATO (MM) RECTIFIED SIZE (MM)	CALIBRO CALIBER
120x120	1190x1190	09
60x120	594x1190	09
60x60	594x594	09

MODULARITÀ MODULARITY

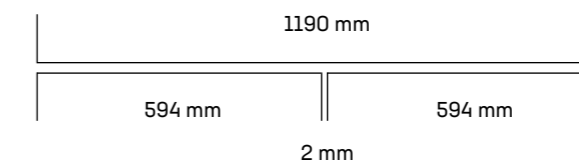

**CARATTERISTICHE TECNICHE
TECHNICAL SPECIFICATION**

LASTRE DI GRES PORCELLANATO / PORCELAIN SLABS
ISO 13006 - G - B1a UGL (E ≤ 0,5%) UNI EN 14411 - G -

	CARATTERISTICHE TECNICHE TECHNICAL SPECIFICATIONS	NORMA ISO STANDARD	SPESSORE THICKNESS	VALORI PRESCRITTI DALLE NORME INTERNATIONAL STANDARDS	VALORE MEDIO GIGACER AVERAGE GIGACER VALUE
	CARATTERISTICHE DIMENSIONALI DIMENSIONAL CHARACTERISTICS			S > 410	
	LATI SIDES	ISO 10545-2		± 0,6%	± 0,2%
	SPESSORE THICKNESS			± 5%	± 3%
	RETTILINEITÀ DEGLI SPIGOLI STRAIGHTNESS OF EDGES			± 0,5%	± 0,2%
	ORTOGONALITÀ RECTANGULARITY			± 0,6%	± 0,2%
	PLANARITÀ SURFACE FLATNESS			± 0,5%	± 0,2%
	ASSORBIMENTO D'ACQUA WATER ABSORPTION	ISO 10545-3		≤ 0,5%	≤ 0,1%
	RESISTENZA ALLA FLESSIONE BENDING STRENGTH	ISO 10545-4	≠ 4.8 mm	≥ 35N/mm ²	≥ 40 N/mm ²
			≠ 12 mm	≥ 35N/mm ²	≥ 40 N/mm ²
	MODULO DI ROTTURA MODULUS OF RUPTURE	ISO 10545-4	≠ 4.8 mm	> 700N (sp. < 7,5mm)	> 700 N
			≠ 12 mm	> 1.300N (sp. ≥ 7,5mm)	≥ 4000 N
	RESISTENZA ALL'ABRASIONE PROFONDA RESISTANCE TO DEEP ABRASION	ISO 10545-6		≤ 175mm ³	≤ 145 mm ³
	COEFFICIENTE DI DILATAZIONE TERMICA LINEARE COEFFICIENT OF LINEAR THERMAL EXPANSION	ISO 10545-8		≤ 9x10 6°c 1	≤ 7x10 6°c 1
	RESISTENZA AGLI SBALZI TERMICI RESISTANCE TO THERMAL SHOCKS			METODO DISPONIBILE AVAILABLE METHOD	RESISTE RESISTANT
	RESISTENZA AL GELO FROST RESISTANCE	ISO 10545-12		METODO DISPONIBILE AVAILABLE METHOD	RESISTE RESISTANT
	RESISTENZA ALL'ATTACCO CHIMICO RESISTANCE TO CHEMICAL ATTACKS	ISO 10545-13		min. UB	RESISTE RESISTANT
	RESISTENZA ALLE MACCHIE STAIN RESISTANCE	ISO 10545-14		METODO DISPONIBILE AVAILABLE METHOD	RESISTE RESISTANT

Trattandosi di un prodotto tecnico a solo impasto senza smalto alcune impurità e puntinature visibili nei colori chiari sono da considerarsi una caratteristica tecnica del prodotto. / We produce technical unglazed porcelain stoneware slabs, and some light impurities and dots must be considered as a standard feature of the product.

**NOTE TECNICHE
TECHNICAL NOTES**

COEFFICIENTE DI ATTRITO / COEFFICIENT OF FRICTION
LASTRE DI GRES PORCELLANATO / PORCELAIN SLABS
ISO 13006 - G - B1a UGL (E ≤ 0,5%) UNI EN 14411 - G -

		SUPERFICI SURFACES	SPESSORE THICKNESS	DIN 51130	DIN 51097	BCR	BRITISH PENDULUM BS7976	R9729 UPI/ EMPA	DCOF (SECTION 9.6 ANSI A 1371.2012)
	COEFFICIENTE D'ATTRITO COEFFICIENT OF FRICTION	ARGILLA MATERIAL	≠4.8 mm	R10	A + B	> 0,40	-	-	-



IMBALLI PACKAGING

Curiamo con particolare attenzione gli imballi del materiale 4,8 mm e 12 mm per scongiurare qualsiasi rischio di rottura dovuta alle sollecitazioni del viaggio. Il cartone utilizzato proviene al 100% da fonti riciclate e il legno, fumigato secondo le norme ISPM-15, sostiene il peso di eventuali pallet (sempre Gigacer) sovrapposti scaricandolo a terra. È importante sovrapporre i pallet dello stesso formato, e non euro pallet con pallet 120x120. Gigacer non si assume nessuna responsabilità per danni causati al materiale da errate manovre di carico o scarico, da movimentazioni non autorizzate o da eventi accidentali di qualsiasi tipo.

We pay close attention to the 4.8mm products packaging, to avoid any risk of breakage during shipping. The cardboards used come from recycled sources 100%, and wood, fumigated according to ISPM-15, supports the weight of any pallet (gigacer pallets) stacked. It is important to stack only pallets of the same size. Gigacer assumes no responsibility for damages caused by incorrect handling of the material loading or unloading, unauthorized handling or accidents of any kind.

Formato Size (cm)	Pallet (cm)	Pezzi x collo PCS/BX	M ² x collo SQM/BX	Kg x collo KG/BX	Colli x pallet BX/PLT	M ² x pallet SQM/PLT	Kg x pallet KG/PLT
12 mm							
120x120	120x120	1	1,44	40,30	36	51,84	1482
60x120	120x120	2	1,44	40,30	36	51,84	1482
60x60	120x120	3	1,08	30,20	48	51,84	1482
Large Pentagon	-	1	1,00	28,00	36	36,00	1048
Brick Bar 7,5x60	80x120	12	0,54	14,00	40	2,16	593
Battiscopa Skirting 60x71	-	10	-	16,00	-	-	-
Gradino costa retta Costa retta step 60x33x4	-	4	-	26,00	-	-	-
Gradino costa retta Costa retta step 120x33x4	-	2	-	26,00	-	-	-
4.8 mm							
120x120	124x137	2	2,88	34,60	23	66,24	835
60x120	124x137	4	2,88	34,60	24	69,12	870
60x60	124x137	5	1,80	21,60	40	72,00	904
Large Pentagon	-	1	1,00	12,00	40	40,00	520
Small Pentagon	-	24	0,96	11,50	24	23,04	316
Button	-	22	0,02	0,39	-	-	-
Small	-	44	0,36	3,95	-	-	-
Brick	-	22	0,36	3,95	-	-	-
Plate	-	22	0,60	6,45	-	-	-
Octagon	-	22	1,98	23,70	-	-	-
Large Hexagon	-	14	1,18	13,00	-	-	-
Small Hexagon	-	11	0,23	3,00	-	-	-
Triangle	-	18	0,24	2,92	-	-	-
Diamond	-	9	0,24	2,92	-	-	-
Mosaic 30x30 (1,5x1,5)	-	10	-	13,00	-	-	-
Mosaic 30x30 (3x6)	-	10	-	13,00	-	-	-
Stripes Mosaic 15x120	-	4	-	7,00	-	-	-
Battiscopa Skirting 120x71	-	8	-	8,00	-	-	-

CERTIFICAZIONI CERTIFICATIONS

GIGACER ha conseguito le certificazioni di processo ISO 9001:2015 e ISO 14001:2015. GIGACER ha conseguito le certificazioni UNI EN 14411:2012.

La qualità dei prodotti GIGACER viene controllata costantemente tramite test effettuati dai principali laboratori ed enti di certificazione internazionali. L'ultima certificazione ottenuta, in ordine di tempo, è la QB-UPEC per alcune superfici, con risultati brillanti.

E' possibile scaricare la lista completa dei prodotti Gigacer che hanno ottenuto la certificazione QB-UPEC, completa di valori, al seguente url: www.cstb.fr

GIGACER has achieved the process certifications ISO 9001:2015 e ISO 14001:2015. GIGACER has achieved the process certifications UNI EN 14411:2012.

The quality of GIGACER products is constantly monitored with tests made by the main international certification laboratories. The last certification achieved is the QB-UPEC in some surfaces, with brilliant results.

It is possible to download the list of Gigacer products that obtained QB-UPEC certification with all the values at the following url: www.cstb.fr



MADE IN ITALY
MADE IN FAENZA

Quanto contenuto nel catalogo è puramente indicativo riguardo a colori e decorazioni. Real colours and decorations might slightly differ from those depicted in this catalogue.

Lined area for notes on the left page.

Lined area for notes on the right page.



GIGACER S.P.A.
via Caltagirone, n.72 / 48018 Faenza (RA) ITALY
Tel. +39 0546 637 111 / Fax +39 0546 637 127
info@gigacer.it

gigacer.it